

BATHROOM
SOLUTIONS

shower+tec

EN-FR-ES

+ profilit+tec
positive profile



shower+tec concept

A place of wellness, relaxation and comfort.

The contemporary bathroom reflects these characteristics and also looks to fast, practical solutions without compromising quality and good taste. With this in mind, Profilitec has created an innovative product that encompasses all the necessary elements to build or renovate an entirely waterproof, maintenance-free shower, quick and easy to install while surpassing the requirements for steam showers.

Un lieu de bien-être, de repos et de confort.

La salle de bains contemporaine offre ces caractéristiques et adopte également des solutions rapides et pratiques sans pour autant compromettre la qualité et le bon goût.

C'est en pensant à tout cela que Profilitec a créé un produit innovant qui englobe tous les éléments nécessaires à la création d'une douche entièrement étanche et sans entretien, rapide et facile à installer, tout en allant au-delà des exigences applicables aux douches à vapeur.

Un lugar de bienestar, relajación y comodidad.

El baño contemporáneo refleja estas características y también busca soluciones rápidas y prácticas sin comprometer calidad y buen gusto.

Con esto en mente, Profilitec ha creado un producto innovador que incluye todos los elementos necesarios para crear o renovar una ducha totalmente resistente al agua sin mantenimiento, rápida y fácil de instalar a la vez que supera los requisitos para duchas de vapor.



SIMPLER / PLUS SIMPLE / MÁS SENCILLO

Pre-attached membrane significantly simplifies installation.

La natte pré-assemblée simplifie considérablement l'installation.

Membrana prefijada que simplifica significativamente la instalación.



FASTER / PLUS RAPIDE / MÁS RÁPIDO

Waterproofed trays and curbs greatly reduce installation time (up to 1 full day).

Les receveurs et bordures étanches réduisent la durée d'installation (jusqu'à 1 journée en moins).

Platos y encintados resistentes al agua que reducen mucho el tiempo de instalación (hasta 1 día entero).



BETTER / MEILLEUR / MEJOR

Waterproof membrane conforming to vapour permeance requirements for steam showers, high density foam, high quality drain grates.

Natte étanche conforme aux exigences de perméance à la vapeur pour les douches à vapeur, mousse à haute densité, grilles d'évacuation de haute qualité.

Membrana resistente al agua conforme con los requisitos de permeancia al vapor para duchas de vapor, espuma de alta densidad rejillas de desagües de alta calidad.



1 Shower Tray
Receveur de douche / Plato de ducha



2 Shower Curb
Bordure de douche / Bordillo de ducha



3 Foiltec Membrane
Natte / Membrana



4 Foiltec Sealing Strip
Bande imperméable / Banda selladora



5 Square Drain Kit
Kit Drain Carré / Kit de Desagüe Cuadrado



Square Grid - 4" (10 cm)
Grille carrée - 4" (10 cm) / Rejilla cuadrada - 4" (10 cm)

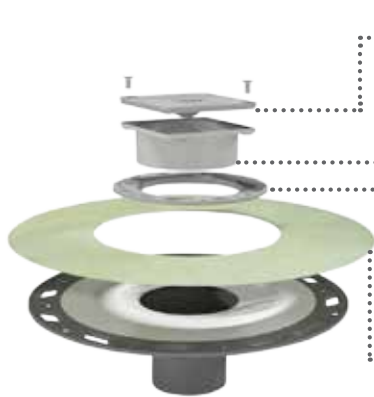

Square Grid Construction Plug
*Bouchon de construction grille carrée
 Tapón de construcción para rejilla cuadrada*

Square Grid Support
Support grille carrée / Soporte para rejilla cuadrada

Square Grid Ring
Anneau grille carrée / Anillo para rejilla cuadrada

Foiltec Circular Waterproof Membrane Ring
*Anneau en natte imperméable Foiltec
 Anillo de membrana impermeabilizante circular Foiltec*

Flange - 2" (5 cm) outlet
Bride - 2" (5 cm) sortie / Brida - Salida de 2" (5 cm)



Foiltec Corners
Foiltec Angles **6 Internal / Rentrant / Internas**
Foiltec Esquinas **7 External / Sortant / Externas**



TRAY and CURB

shower+tec - SHOWER TRAY

Showertec Shower Tray is pre-sloped incorporating the Foiltec Waterproof and Vapour Tight Membrane, which is pre-attached, assuring simple and quick installation while surpassing the requirements for steam showers.

Le Receveur de Douche Showertec de Profilitec est un receveur à pente préfabriquée, avec Natte Foiltec pré-assemblée, étanche à l'eau et à la vapeur.

El Plato de Ducha Profilitec Showertec es un plato preinclinado con membrana prefijada Foiltec resistente al agua y hermética al vapor.

STC-TRAY91/91

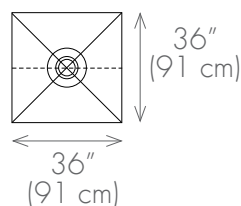

STC-TRAY122/122

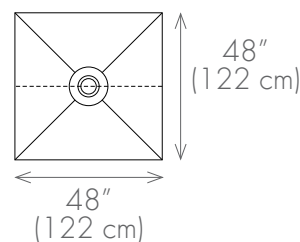

STC-TRAY81/152

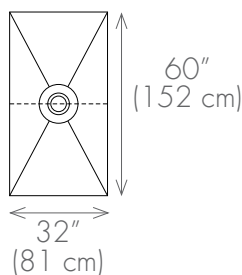

STC-TRAY81/152D

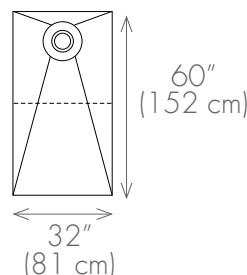

STC-TRAY183/183

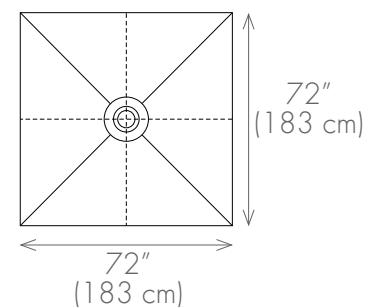

shower+tec - SHOWER CURB

Showertec Shower Curb is made of high density EPS foam and is pre-wrapped in Foiltec Waterproof Membrane on all sides. An opening along the curb allows height adjustment if needed.

La Bordure de Douche Showertec est réalisée en mousse d'EPS haute densité et est pré-emballée dans la Membrane d'étanchéité Foiltec sur tous les côtés. Une ouverture le long de la bordure permet d'ajuster la hauteur si nécessaire.

El Bordillo de Ducha, está realizada en espuma EPS de alta densidad y está preenvuelta en Membrana Foiltec resistente al agua en todos los lados. Una abertura a lo largo del encintado permite el ajuste de altura si es necesario.



A = 6" (15 cm)

A1 = 3" (7.5 cm)

B = 4.5" (11.5 cm)

Showertec Shower Curb is available in two lengths: 36" (91 cm) and 48" (122 cm).

La Bordure de Douche Curb est disponible en deux longueurs : 36" (91 cm) et 48" (122 cm).

El Bordillo de Ducha está disponible en dos longitudes: 36" (91 cm) y 48" (122 cm).



Showertec Foiltec Water-Stop advantages / avantages / ventajas



Waterproof & vapor tight Membrane

Étanche à l'eau et à la vapeur

Resistente al agua y hermética al vapor



Pre-attached waterproof Membrane

Natte étanche pré-assemblée

Membrana resistente al agua prefijada



0,033 perm rating (ASTM E96-E)

0,033 de perméance nominale (ASTM E96-E)

Índice de permeabilidad 0,033 (ASTM E96-E)



Semi-rigid material for ease of installation

Matériau semi-rigide pour faciliter l'installation

Material semirrígido para una instalación fácil

Materials / Matériels / Materiales



Bonding Flange in PVC or ABS

Bride de liaison en PVC ou en ABS

Brida de adhesión en PVC o ABS



Flange with high strength bonding surface

Bride avec surface de liaison à haute résistance

Brida con superficie de adhesión de alta solidez

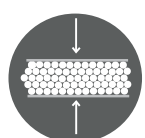

High density EPS

EPS de densité plus

EPS con mayor densidad



EPS foam contains recycled content

La mousse d'EPS contient une partie de produit recyclé

Espuma EPS con contenido reciclado



Finishes and accessories / Finitions et accessoires / Acabados y accesorios



High quality brushed and polished finishes

Finitions brossées et polies de qualité élevée

Acabados cepillados y pulidos de alta calidad



Construction Plug

Bouchon de Construction

Tapón de construcción

Technical features / Caractéristiques techniques / Características técnicas



Pre-sloped Tray

Receveur de douche à pente préfabriquée

Plato de ducha preinclinada

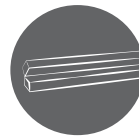

Curb with modular height flexibility

Modularité en hauteur

Altura de bordillo variable

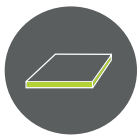

Frameless solid metal Grid (stainless steel and aluminum)

Grille métallique pleine sans cadre (acier inoxydable et aluminium)

Rejilla de metal sólido sin marco (acero inoxidable y aluminio)



Significant lateral Grid adjustment

Alignement latéral de grille appréciable

Ajuste notable de rejilla lateral



ASTM E96-13
ASTM E96-15
ASTM C627-10



ANSI A118.10-2008

SQUARE DRAIN

shower⁺tec - SQUARE DRAIN KIT

Showertec Square Drain Kit is composed of a bonding Flange with a vertical drain and an integrated anchoring membrane, a Foiltec Circular Waterproof Membrane Ring, Foiltec Internal and External Corners and a Square Drain which is composed of: a ring for the vertical alignment of the drain, a grid support, a construction plug, a grid and fasteners.

Le Kit de Drain Carré Showertec se compose d'une Bride de liaison avec un drain vertical et d'une natte à ancrage intégré, d'un Anneau Circulaire Foiltec en natte étanche, d'Angles Foiltec internes et externes et d'un Drain Carré comprenant un anneau pour l'alignement vertical du drain, un support de grille, un bouchon de montage, une grille et des vis.

El Kit de Desagüe Cuadrado Showertec está compuesto por una Brida de adhesión con un desagüe vertical y una membrana de anclaje integrada, un Anillo Membrana Circular Foiltec resistente al agua, unas aristas internas y externas Foiltec y un Desagüe Cuadrado que está compuesto por: un anillo para la alineación vertical del desagüe, un Soporte de Rejilla, un Tapón de Construcción, y una rejilla y tornillos.

Various grid finishes available / Différentes finitions disponibles / Varios acabados disponibles :



IL

Polished Stainless Steel AISI 304

Acier Inoxydable Poli AISI 304

Acero Inoxidable Pulido AISI 304



IS

Brushed Stainless Steel AISI 304

Acier Inoxydable Brossé AISI 304

Acero Inoxidable Cepillado AISI 304



ASSB

**Brushed Polished Chrome
Aluminum**

*Alliage Chrome Aluminium
Poli Brossé*

*Aluminio Cromado Pulido
Cepillado*



AMSB

**Brushed Antique Bronze
Aluminum**

*Alliage Bronze Aluminium
Brossé Antique*

*Aluminio Bronce Antiguo
Cepillado*



ATSB

**Brushed Polished Titanium
(nickel) Alum.**

*Alliage Titane (nickel)
Aluminium Poli Brossé*

*Aluminio Titanio (níquel)
Pulido Cepillado*



positive profile

Profilitec S.p.A.

Via Scotte, 3
36033 Isola Vicentina
(Vicenza) Italy

profilitec@profilitec.com
export@profilitec.com

+39 0444 268311



Profilitec Corp.

472 Meeting Street -
Suite C, #301

Charleston, SC
29403

customerservice@profilitec.com

+1 855 290 9591



www.profilitec.com

